

H2 Tork Xpress®

552000, 552008, 460004, 552100 & 552108



552000



552008



460004





552100

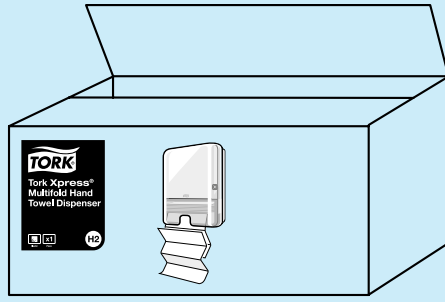

552108



-  x 1
-  x 4
-  x 4

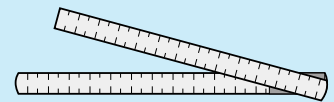
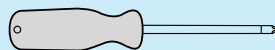
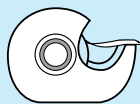
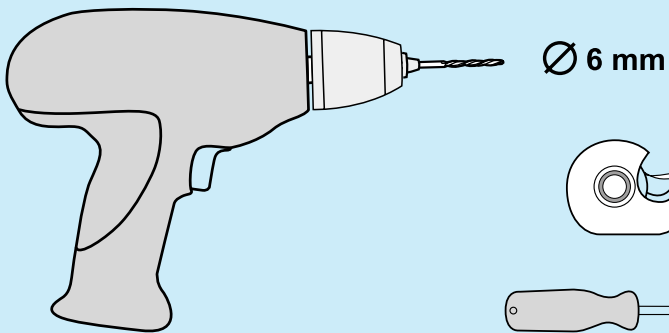
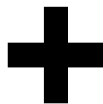
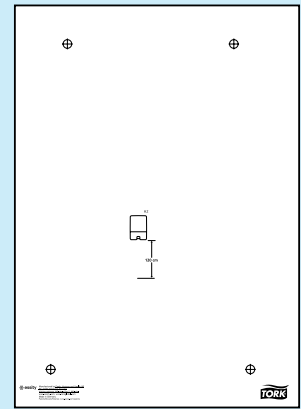
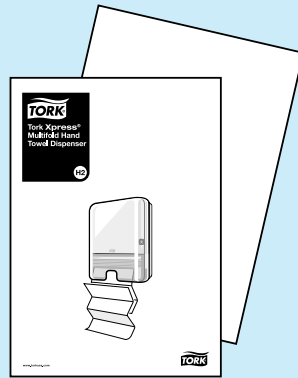
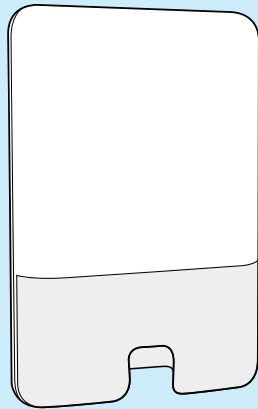

1

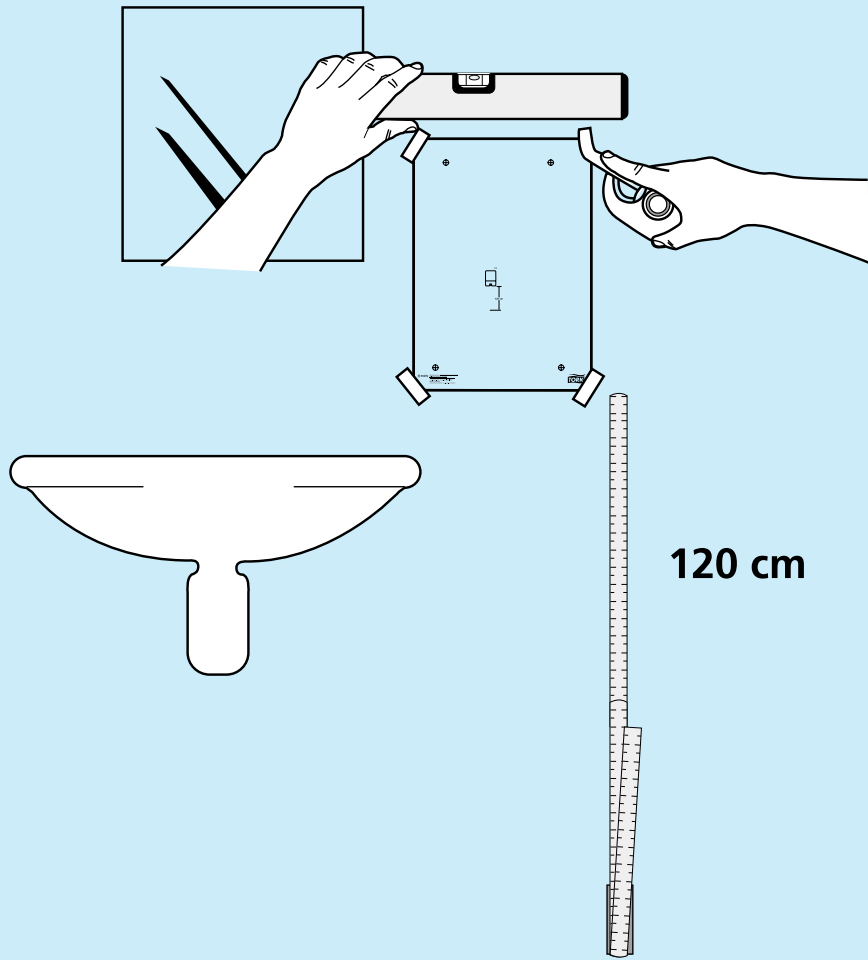

2

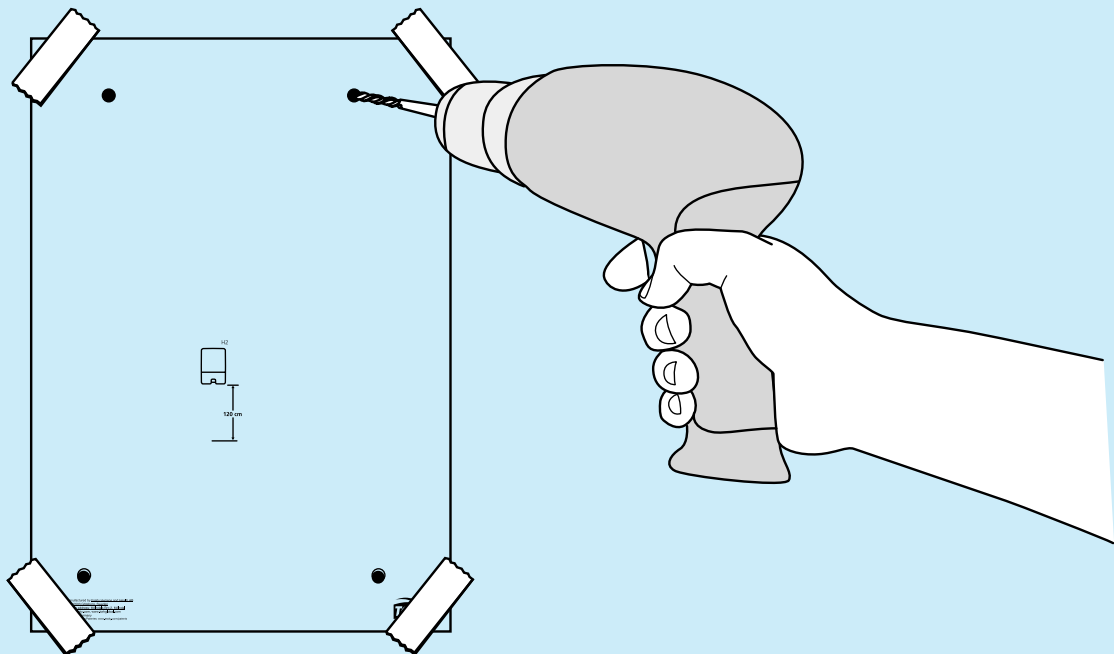

3

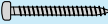
-  x 2
-  x 2

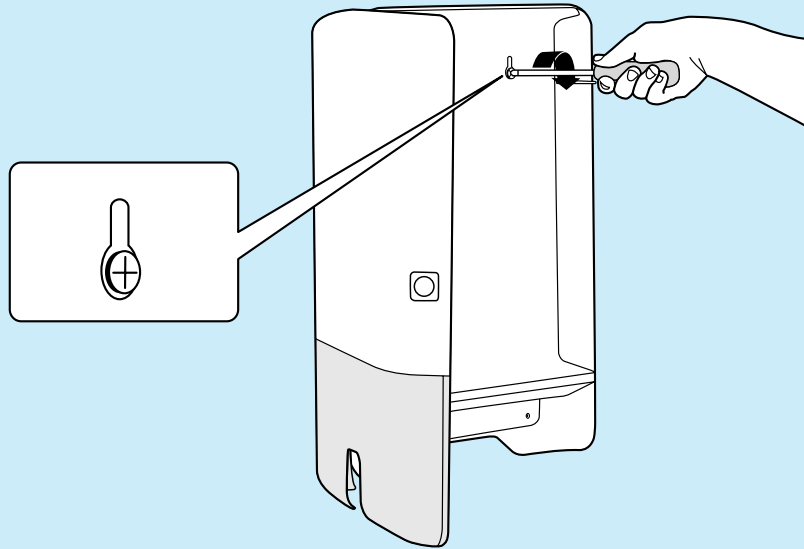

4

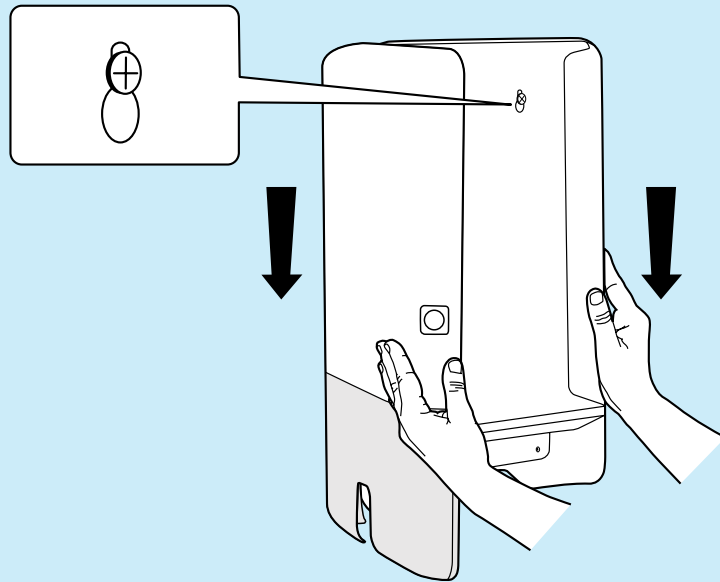

5

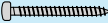
-  x 2
-  x 2

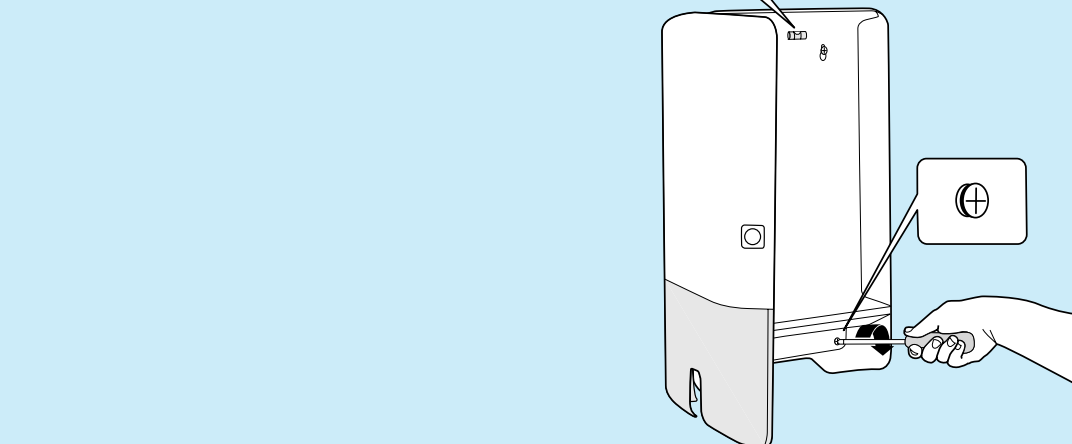
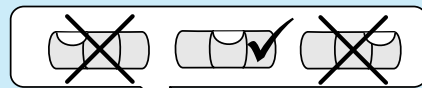

1

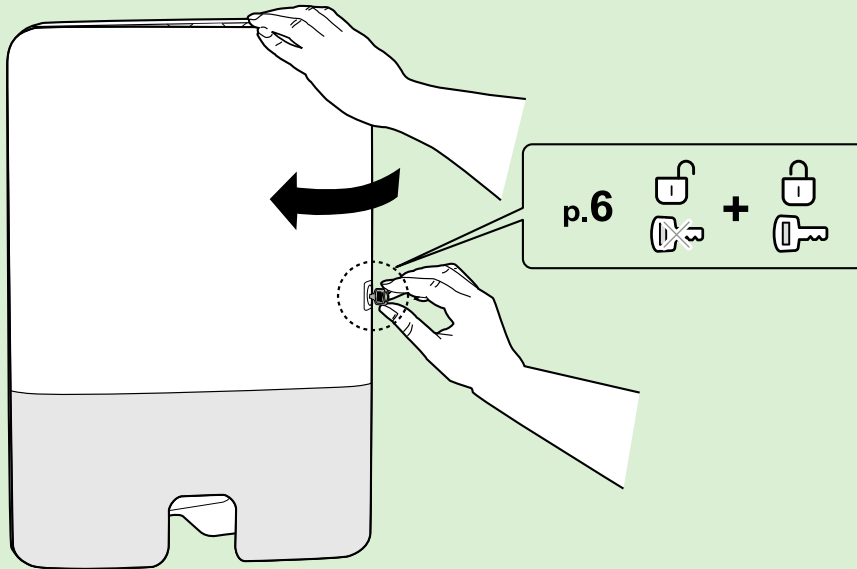

2

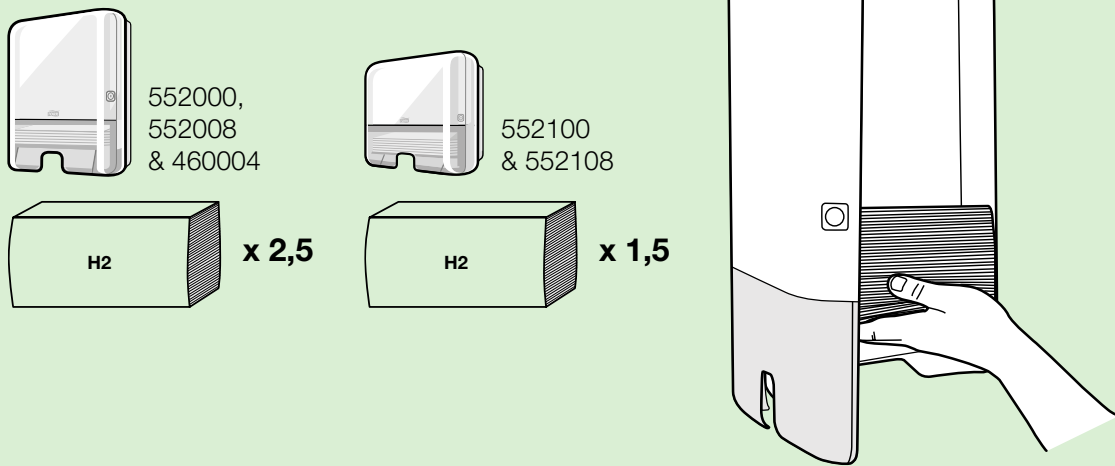

3

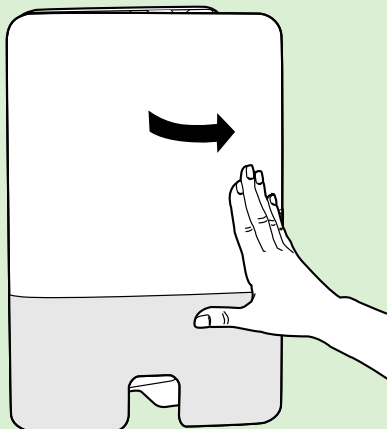

4

